



## About the BLRD

The BLRD recessed LED luminaire is perfect for office spaces, offering a clean, professional appearance with energy-efficient performance. ETL certified and easy to install makes this product an excellent choice for retrofits and new installations.

## Specifications

Supported Voltage	120-277V, 347V, 120-347V
Available Sizes	1x4, 2x2, 2x4 (all metric and custom sizes available on request)
Lifetime	L70 of 150,000+ hours, L90 of 45,000+ hours
Lumens	2L (2000lm) to 10L (10000lm)
CCT	2700K, 3000K, 3500K, 4000K, 5000K, 6500K
CRI	80+ standard, 90+ and 95+ available
Dimming	0-10V Standard
Mounting	Recessed lay-in fixture for T-Bar Ceilings. Holes provided for chain or hanger, and wire mounting support for T-Bar ceilings

## Approvals

- ETL Listed
- Dry and Damp Environment Rated

## Ordering Information

Fill in the fields below with your product selections. If you need help with this section, [contact your local sales professional](#).

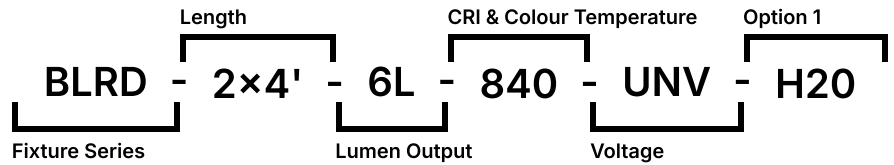

1	2	3	4	5				
Series	Length & Lumen Output		CRI	CCT	Voltage			
BLRD	1x4' - 2L	2000 lm	2x4' - 3.5L	3500 lm	8 80	27 2700K	UNV	120-277V
	1x4' - 2.5L	2500 lm	2x4' - 4L	4000 lm	9 90+	30 3000K	347	347V
	1x4' - 3L	3000 lm	2x4' - 4.5L	4500 lm	1 95+	35 3500K	UN3	120-347V
	1x4' - 3.5L	3500 lm	2x4' - 5L	5000 lm		40 4000K		
	1x4' - 4L	4000 lm	2x4' - 5.5L	5500 lm		50 5000K		
	1x4' - 4.5L	4500 lm	2x4' - 6L	6000 lm		65 6500K		
	1x4' - 5L	5000 lm	2x4' - 6.5L	6500 lm				
	2x2' - 2L	2000 lm	2x4' - 7L	7000 lm				
	2x2' - 2.5L	2500 lm	2x4' - 7.5L	7500 lm				
	2x2' - 3L	3000 lm	2x4' - 8L	8000 lm				
	2x2' - 3.5L	3500 lm	2x4' - 8.5L	8500 lm				
	2x2' - 4L	4000 lm	2x4' - 9L	9000 lm				
	2x2' - 4.5L	4500 lm	2x4' - 9.5L	9500 lm				
	2x2' - 5L	5000 lm	2x4' - 10L	10000 lm				
	2x4' - 3L	3000 lm						

## Options

### Lenses

BLANK | Frosted Acrylic

### Dimming

- B11 | 0-10V Dimming Leads
- B12 | Line Voltage Dimming
- B27 | Dim-to-off Driver
- B\*\* | Other Options Available

### Controls

- WC10 | Encelium Wireless Controls
- WC18 | NX Wireless Controls
- WC19 | Avi-on Wireless Controls
- WC22 | JDRF Wireless Controls

### Motion Sensors

- WX15 | Internal Dimming Low Voltage Microwave Sensor
- WC20 | Leviton Low-Voltage Sensor
- W\*\* | Other Options Available

### Emergency Driver

- B17 | UL924 10W Battery Back-up
- F8 | UL924 Emergency Relay

### Air Handling

- H20 | Housing with Passive Air Handling
- H24 | Housing with Active Air Handling

### Finish

- BLANK | Standard Low Reflectance White
- C5 | Matte Black
- CUSTOM | Custom Colour Choice

### Packaging

- BLANK | Individually Boxed on Pallets
- P0 | Bulk Packaging
- P\*\* | Other Options Available

### Mounting

- M15 | Surface Mount Kit (packaged separately)
- BLANK | 15/16" T-Bar
- TB39 | 9/16" T-Bar
- TB39S | 9/16" T-Bar (Slotted)
- H40 | Drywall Kit (packaged separately)

### Warranty

- CL7 | 10-Year Comprehensive Warranty Upgrade

## Documentation and Resources

All files and resources are available on our website for download. Files and resources are also embedded as links in this document, listed below. Additional files may be available upon request.  
Please contact your local sales agent [here](#) or contact [sales@bjtake.com](mailto:sales@bjtake.com) for more information.





 [BLRD-1x4-5L-840-L18.ies](#)

 [BLRD-1x4-7L-840-L18.ies](#)

 [BLRD-2x4-6L-840-L18.ies](#)

## Certifications and Listings

Certifications that apply to this fixture and its possible configurations are listed here. More information available upon request.

Icon	Description
	Wireless Controls Available
	90 and 95+ CRI Options Available
	120-347V(UN3) Available
	ETL Listed
	Passive/Active Air Handling Options

## Usage Applications

This fixture can be used in a variety of applications, and is ideal for the following:

Usage Application
Hospitals
Offices
Schools

## Warranty Statement

BJ Take products are tested and/or inspected prior to being packaged for shipment and are guaranteed from the day the product is shipped for a period of ten-year LED chip warranty and a five-year comprehensive component warranty. This can be upgraded to a ten-year comprehensive warranty on request.

### Wattage Information

Below are the wattage tables for all size formats of the BLRD.

#### BLRD 1x4' Wattage

Size	Lumen Output	Fixture Wattage
14	2.0	14.8
14	2.5	18.4
14	3.0	22.1
14	3.5	25.8
14	4.0	29.5
14	4.5	33.2
14	5.0	36.8

#### BLRD 2x2' Wattage

Size	Lumen Package	Wattage
22	2.5	19.8
22	3.0	24.1
22	3.5	28.4
22	4.0	33.1
22	4.5	37.9
22	5.0	42.7

#### BLRD 2x4' Wattage

Size	Lumen Package	Wattage
24	3.0	21.7
24	3.5	25.3
24	4.0	29.0
24	4.5	32.7
24	5.0	36.3
24	6.0	43.7
24	7.0	51.0
24	8.0	58.4
24	9.0	65.7
24	10.0	73.0

#### BLRD 2x4' Light Loss Factor (LLF)

CCT	Output%
2700K	92.95%
3000K	95.51%
3500K	96.80%
4000K	100%
5000K	101.28%
90CRI	84.72%

\* Actual lumen output may vary

## Dimension Information

Below you will find the dimensions for both sizes of the BLRD.

### BLRD 1x4'

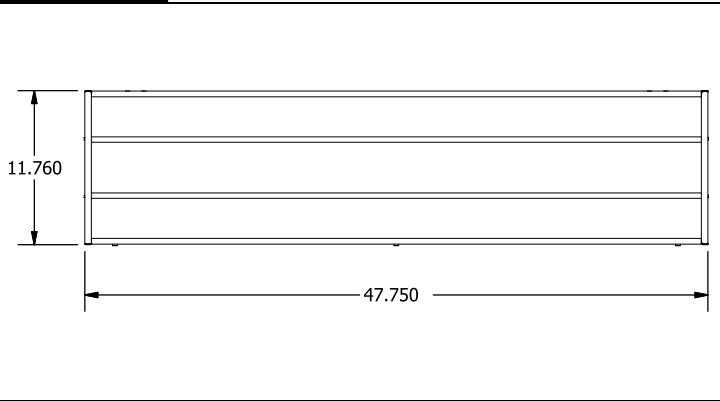

### End Dimensions

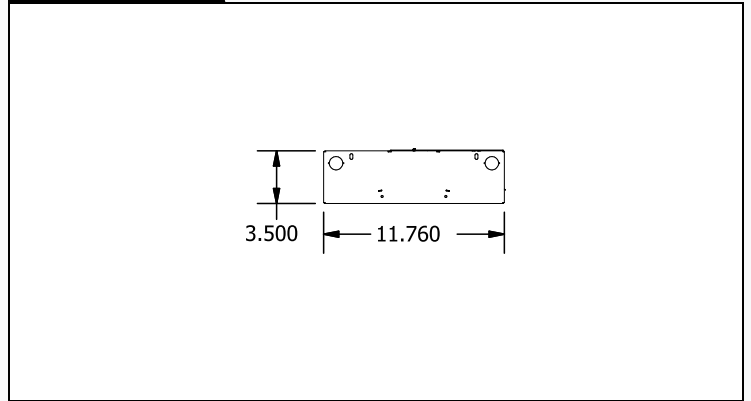

### BLRD 2x2'

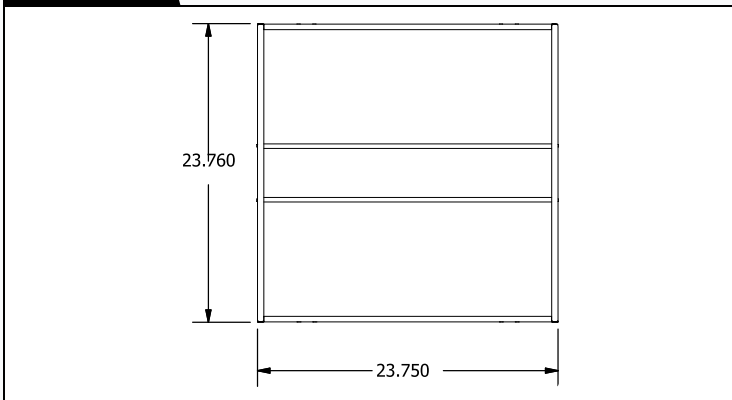

### End Dimensions

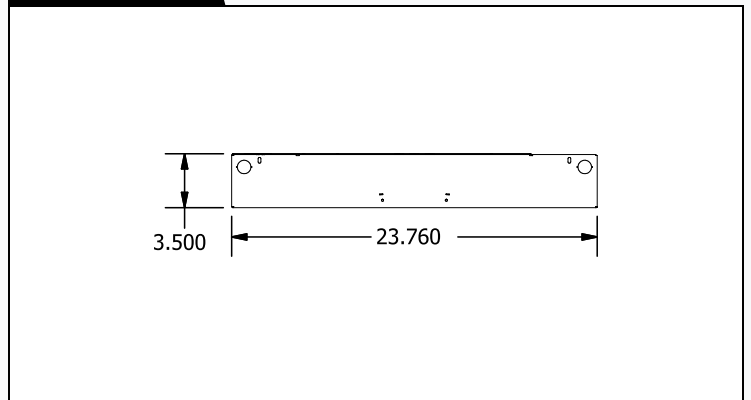

### BLRD 2x4'

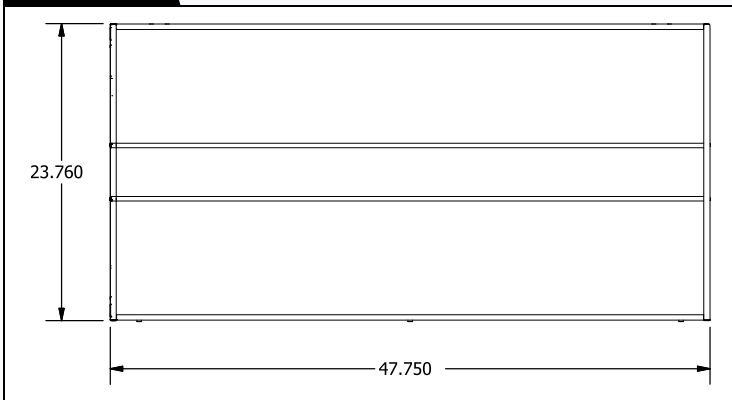

### End Dimensions

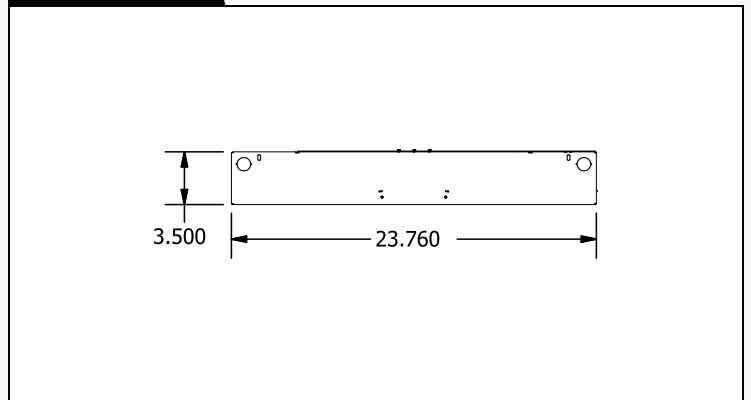

\* Drawings aren't to scale

\* Standard tolerances apply

\* Specifications may change without notice

**BLRD-2X4-6L-840-L18**

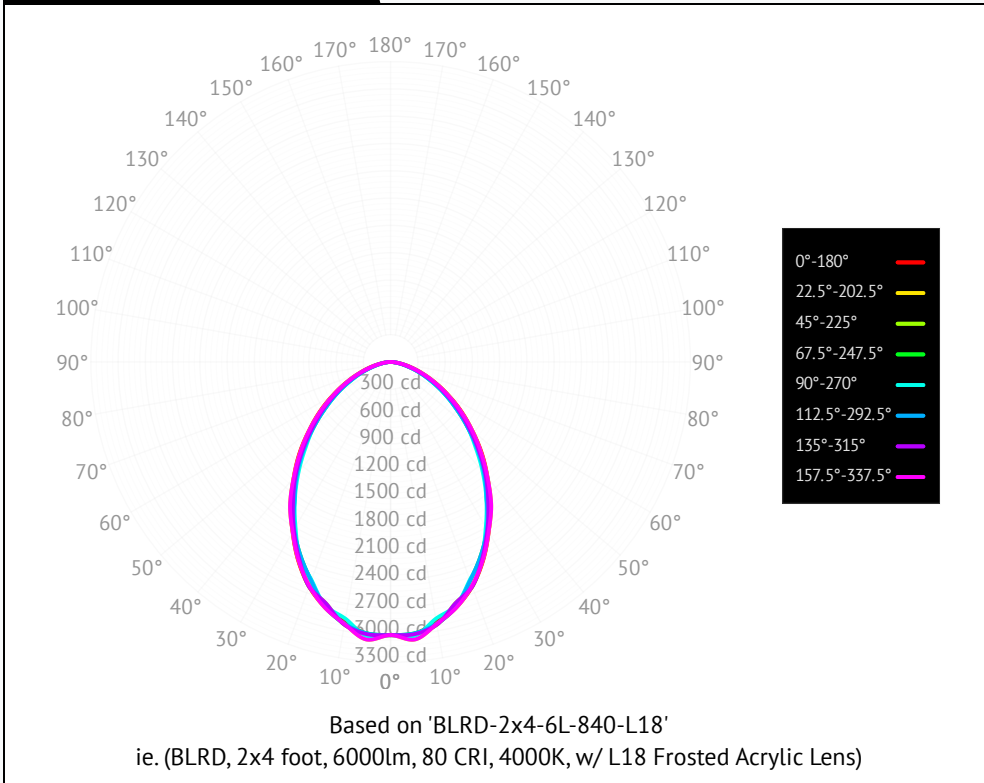

**Cone of Light**

Mtg Height	Light Level	Beam Diameter
6.0 ft	83.4 fc	11.1 ft
8.0 ft	46.9 fc	14.8 ft
10.0 ft	30.0 fc	18.5 ft
12.0 ft	20.8 fc	22.1 ft
14.0 ft	15.3 fc	25.8 ft
16.0 ft	11.7 fc	29.5 ft

## Gallery Information

Below you will find images of relevant products and configurations for the BLRD.

